

INFINITY 2

INFINITY SERIES

70 x 35 x 30 3/4 inches

AIR-WHIRLPOOL MODEL #WI2INF7135A



Not a drop-in model. Deck must be built around unit.

FEATURES ~

- Raised seating
- Sculpted armrests
- Extra-soft magnetic comfort pillow
- Adjustable metal base
- Slip resistant floor
- Premium cast acrylic surface
- Limited lifetime warranty

SYSTEM FEATURES *(standard)*

AIR-WHIRLPOOL COMBINATION

- Electronic control with preset capability
- 16 hydrotherapy jets
 - 12-jet heated-air shiatsu back massage system
 - Leg and foot jets
- Whirlpool pump
- 1.5kW inline maintenance heater
- High intensity LED chromatherapy light
- In-floor illusion air injectors
- Variable speed heated-air blower with wave and pulse modes
- Air system purge and dry cycle



Rev. 06.01.18

INFINITY 2

70 x 35 1/2 x 30 3/4 inches

BASE MODEL	PKG. WT. LBS.	JETS	DRAIN	MODEL #	MSLP
Air-Whirlpool	356	16	Univers.	W2INF7135A	\$8,280

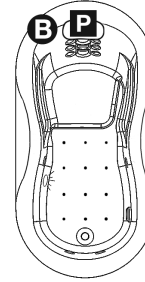

INFINITY

PRODUCT FEATURES

Note: Not a drop-in model.
Deck must be built around unit.

For series features see section page.

ILLUSTRATION KEY

- P** = Pump Location
- B** = Blower Location

ORDERING KEY

In the part number, "xx" means an option code must be inserted.

Acrylic stock color (COLxx) ← part number

option code → White (WH)

Example: COLxx + WH = COLWH
Acrylic stock color in White

Manufacturer reserves the right to discontinue models, colors, options and trim finishes without notice.

OPTIONS (x = insert desired option code)	ENTER DESIRED OPTION CODE	MSLP
Cast acrylic stock color (COLxx): White (WH)	_____	No charge
Cast acrylic color upgrade (COLxx): Biscuit (BI)	_____	\$35
Cast acrylic premium color upgrade (COLUxx): Black (BK) Sterling Silver (ST)	_____	\$389
Magnetic pillow (MPxxxxx): White (WHPI) Black (BKPI)	_____	No charge
Cable drive waste & overflow: Chrome (CDCHCD)	_____	\$345
Cable drive waste & overflow, color-matched (CDxxxx): Biscuit (BICD) White (WHCD)	_____	\$390
Cable drive waste & overflow (CDxxxx): Oil Rubbed Bronze (OBCD) Polished Brass (BRCD) Brushed Nickel (SNCD)	_____	\$440
Metallic trim: Chrome (MTCH)	_____	\$540
Metallic trim (MTxx): Polished Brass (BR) Brushed Nickel (SN)	_____	\$675
Fast-fill waterfall spout (SPWF5)	_____	\$525
Rush order program* (DELQK)	_____	\$325
Residential delivery* (DELRD)	_____	\$205
Residential delivery with lift gate* (DELLG)	_____	\$454

*For program terms and conditions, see page iii.

BASE PRICE (insert MSLP of base model selected in upper table)	+ \$ _____
OPTIONS SUB TOTAL	\$ _____
ORDER TOTAL	= \$ _____

Customer Name: _____ Date: _____

Additional Information:

INFINITY 2

70 x 35 x 30 3/4 inches

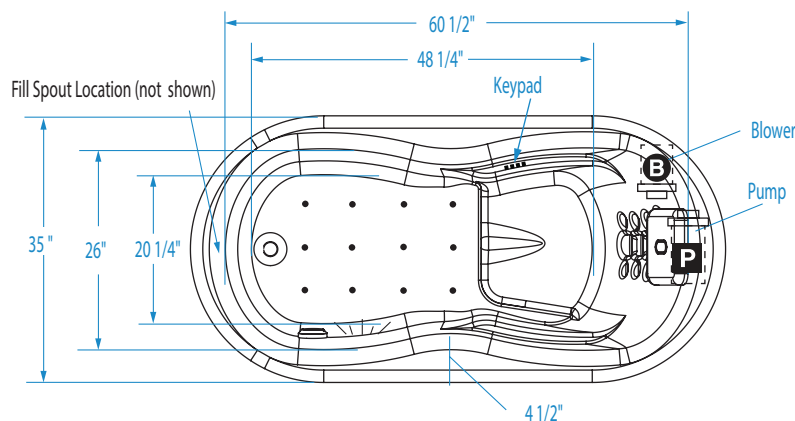

No alternate pump location available.

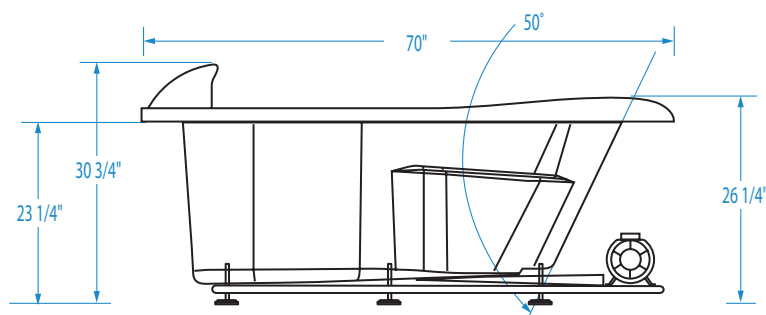

Note: Infinity 2 is not a drop in model. A deck must be built around the tub.

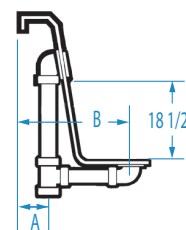

Not a drop-in model. Deck must be built around unit. This unit has a 3/4" female waterfall fill spout connection.

FEATURES

Dimensional Tolerance $\pm 3/8"$. Dimensions needed for site preparation should be measured from the unit. Aquatic assumes no responsibility for preparatory work.

Type and Model #	Material	Jets	Pump	Air System	Blower	Heater	Controls	Drain	Pkg. Wt. lbs.
Air-whirlpool #WI2INF7135A	Cast Acrylic	16	102 GPM	Injector	Variable speed	1.5 kw Inline	Electronic	Universal	356

DIMENSIONS inches

Width Overall / Net	Depth Overall / Net	Height Overall / Net	Skirt Height
70	35	30 3/4	-

SUMP DATA inches

Capacity to Overflow gal (ltr)	Min. Operating Capacity gal (ltr)	WIDTH @ centerline		DEPTH @ centerline	
		Top	Bottom	Top	Bottom
102	69	60 1/2	48 1/4	26	20 1/4

PLUMBING DIMENSIONS inches

A	B	Drain Diameter / Clearance
2 3/8	9 1/2	2 / 2 3/4

ELECTRICAL DATA

Component	Specification	Requirement
Pump	9 AMP; 120 V	15 AMP 1 pole, separate circuit, Class A GFCI
Inline Heater	1.5 kW; 12 AMP; 120 V	15 AMP 1 pole, separate circuit, Class A GFCI
Blower	1.0 HP; 9.5 AMP; 120 V	15 AMP 1 pole, separate circuit, Class A GFCI

NOTES:

1) Where applicable, utilize cut-out templates packed with unit for deck cutouts.

2) 16 x 16 minimum access required at pump/blower location(s).